

AIRTECH

Architectural design

FLORIM È CERTIFICATA B CORP

FLORIM IS B CORP CERTIFIED

Guardiamo al business come una forza positiva in grado di generare profitto e allo stesso tempo creare un impatto virtuoso sulle persone e sull'ambiente. Da sempre.

Le nostre scelte, giorno dopo giorno, ci hanno portato a migliorare il nostro modo di fare impresa.

We conceive the business as a positive force able to generate profits and at the same time create a virtuous impact on people and the environment. Since forever.

Our choices, day after day, have led us to improve our way of doing business.

COSA SIGNIFICA ESSERE B CORP?

Ci siamo misurati con i **più alti standard di performance sociale e ambientale** e dopo un lungo e rigoroso processo di verifica **siamo diventati B Corp.**

Le aziende che riescono a ottenere questa certificazione sono le più evolute al mondo in termini di impatto positivo sia sociale che ambientale.

Costituiscono un movimento globale di 'Purpose Driven Businesses' che ha l'obiettivo di diffondere un nuovo **paradigma economico**, che vede le imprese come protagoniste nel **rigenerare la società**.



Certified



Corporation



Guarda il video *"Essere sostenibili è una scelta quotidiana"* con i volti di alcune delle "persone Florim" che ogni giorno contribuiscono a rendere l'azienda sempre più responsabile.

Watch the video "Being sustainable is a daily choice" with the faces of some of the "Florim people" who contribute to making the company even more responsible, every day.

WHAT DOES IT MEAN TO BE B CORP?

We vied with the **highest social and environmental performance standards**, and after a long and scrupulous verification process, **we became B Corp.**

Companies that succeed in obtaining this certification are the most evolved in the world in terms of their positive social and environmental impact.

They constitute a global movement of 'Purpose Driven Businesses' whose aim is to diffuse a **new economic paradigm**, whereby companies are the drivers of **social regeneration**.

FOR
PROFIT

Ricerca
il profitto
Seeks profit

Certified



Corporation

Ricerca il profitto e ha un impatto positivo sulle persone e l'ambiente
Seeks profit and has a positive impact on people and the environment

NON
PROFIT

Ha un impatto positivo sulle persone e l'ambiente
Has a positive impact on people and the environment

BUSINESS RIGENERATIVO

È in corso un **cambiamento culturale** epocale di cui siamo orgogliosi di essere parte. Uno dei principi fondamentali di tutte le B Corp è quello di adottare un business rigenerativo che si contrappone a quello estrattivo.

Rigenerare significa non solo diminuire l'impatto sulla natura e sull'ambiente che ci circonda, ma addirittura produrre effetti positivi, creando valore condiviso nella società e rigenerando la biosfera.

Diventano B Corp solo quelle aziende che misurano il loro impatto complessivo attraverso il Benefit Impact Assessment (BIA) superando il punteggio di 80 (in una scala da 0 a 200) ed entrando così in una élite di imprese **rigenerative**. Chi non supera questa soglia viene considerata **azienda estrattiva** ovvero per funzionare consuma risorse economiche, sociali e ambientali superiori di quanto sia in grado di generare come output.

REGENERATIVE BUSINESS

An historical **cultural shift** is under way, of which we are proud to be a part. One of the underlying principles of all B Corps is the adoption of a regenerative business model as opposed to an extractive one.

Regenerating means not only reducing the impact of business on our surrounding nature and environment, but also producing **positive effects, creating shared value in society and regenerating the biosphere**.

Only those companies that measure their overall impact through the Benefit Impact Assessment (BIA) exceeding the score of 80 points can be certified as B Corp, joining an elite of **regenerative** companies. Anyone who does not exceed this threshold is considered an **extractive company** or, in order to function, they consume higher economic, social and environmental resources than they are able to generate as output.

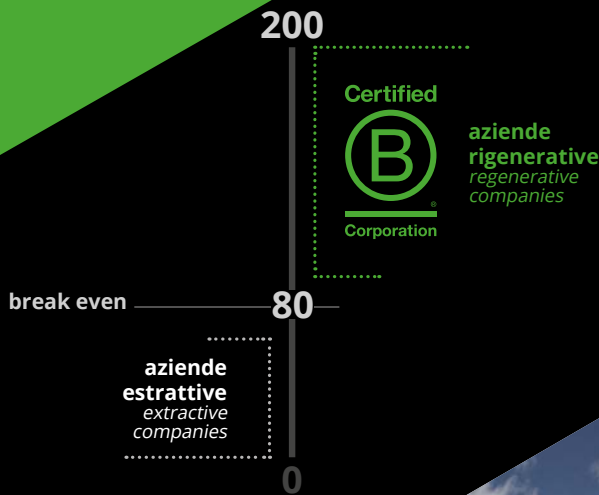

IL PUNTEGGIO DI FLORIM

Il punteggio conseguito da Florim Italia è di 98,1 punti e il consolidato, che comprende la consociata americana, è di 90,9 punti. Così Florim rientra tra le migliori B Corp al mondo.

Solo il 3% delle aziende riesce a superare l'iter di verifica imposto da **B Lab**, ente certificatore di origine americana che oggi opera a livello globale.

FLORIM'S SCORE

Florim Italia score is 98.1 points and the consolidated, which includes the American subsidiary, is 90.9 points. Florim is now one of the best B Corps throughout the world.

Only 3% of companies manage to pass the verification process implemented by **B Lab**, the US certifying body that currently operates on a global scale.

90.9

Florim consolidato
Florim consolidated

98.1

Florim Italia
Florim Italy

Architectural design

Materiale tecnico seguendo le tendenze dell'architettura, per applicazioni quali pavimentazioni industriali e realizzazioni pubbliche a medio e ad alto traffico, come aeroporti, centri commerciali, ristoranti, uffici, negozi, ma anche applicazioni residenziali con un mirato contenuto estetico.

Technical material in line with architectural trends, for applications such as industrial flooring and public buildings with medium to high footfall, such as airports, shopping centres, restaurants, offices, shops, as well as residential applications featuring a targeted aesthetic content.

Matériau technique suivant les tendances de l'architecture, pour des applications en tant que sols industriels et des réalisations publiques à trafic moyen et intense, comme les aéroports, les centres commerciaux, les restaurants, les bureaux, les magasins, mais aussi pour des applications résidentielles au contenu esthétique ciblé.

Technisches Material im Einklang mit den architektonischen Trends für Anwendungen wie Industrieböden und mittelhoch bis stark frequentierte öffentliche Bereiche wie Flughäfen, Einkaufszentren, Restaurants, Büros und Läden, aber auch für Wohngebäude mit wertiger Optik.

Material técnico que sigue las tendencias de la arquitectura, creado para pavimentos industriales y ambientes públicos de mediano y alto tránsito —como aeropuertos, centros comerciales, restaurantes, oficinas y tiendas—, pero también para aplicaciones residenciales con un refinado contenido estético.

performance



appeal



nl

project



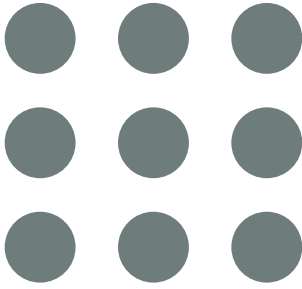

AIRTECH



Architectural design





AIRTECH





La continua evoluzione architettonica e i nuovi stili di vita sono sempre più orientati alla ricerca di ambienti osmotici in cui il dentro sconfini nel fuori con una informalità naturale. Per questo diventa necessario trovare una superficie fluida adatta alla creazione di luoghi che dialoghino tra loro in modo uniforme e discreto. **Airtech** è stata pensata per integrarsi in tutti gli spazi in cui il proprio istinto progettuale possa lasciare un segno distintivo. Un sistema completo di superfici, colori e formati definiscono potenzialità inattese.





AIRTECH

The constant evolution of architecture and our new lifestyles have led more and more towards the search for osmotic environments where the inside encroaches on the outside spaces with a natural informality. This is why it becomes necessary to find a fluid surface suitable for creating places that will dialogue with each other uniformly and discreetly. **Airtech** has been devised to integrate into all spaces in which one's instinct for design can leave a distinctive mark. A complete system of surface finishes, colours and sizes highlight unexpected potentialities.

L'évolution architecturale constante et les nouveaux styles de vie sont de plus en plus orientés vers la recherche d'espaces osmotiques où l'intérieur empiète sur l'extérieur avec une informalité naturelle. Il devient ainsi nécessaire de trouver une surface fluide adaptée à la création de lieux en mesure de dialoguer entre eux de façon uniforme et discrète. La série **Airtech** a été conçue pour s'adapter à tous les espaces pouvant se distinguer par l'instinct de l'architecte. Un système complet de surfaces, de couleurs et de formats qui définissent des potentialités surprenantes.



Die kontinuierliche Entwicklung in der Architektur und die neuen Lebensstile orientieren sich mehr und mehr an der Suche nach einem osmotischen Ambiente, in dem das Innere mit einer natürlichen Informalität an das Äußere grenzt. Aus diesem Grund ist es notwendig, eine fließende Oberfläche für die Gestaltung von Räumen zu finden, die auf einheitliche und diskrete Weise miteinander kommunizieren. **Airtech** wurde entwickelt, um in allen Räumlichkeiten zu passen, in denen der Designinstinkt eine unverwechselbare Note hinterlassen kann. Ein komplettes System von Oberflächen, Farben und Formaten definiert ein unerwartetes Potenzial.

La continua evolución arquitectónica y los nuevos estilos de vida están cada vez más orientados a la investigación de ambientes osmóticos en los que el interior invade el exterior con una informalidad natural y, precisamente por eso, encontrar una superficie fluida que se adapte a la creación de lugares que dialoguen entre sí de forma homogénea y discreta se convierte en una necesidad. **Airtech** se ha pensado para integrarse en todos los espacios en los que el propio instinto de diseño pueda dejar una marca distintiva. Un sistema completo de superficies, colores y formatos definen potencialidades inesperadas.

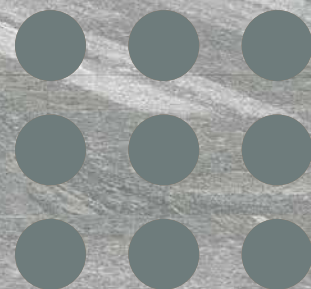



floor: miami_white naturale 80x80 31^{1/2}"x31^{1/2}"





wall: **basel_grey modulo listello sfalsato** naturale 21x40 8^{1/4}"x15^{3/4}"
floor: **basel_grey** naturale 60x120 23^{5/8}"x47^{1/4}"





wall: basel_grey modulo listello sfalsato naturale 21x40 8^{1/4}"x15^{3/4}"
floor: basel_grey naturale 60x120 23^{5/8}"x47^{1/4}"



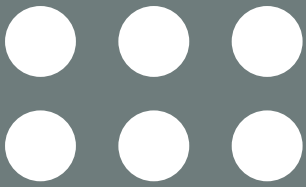

floor: new_york_light grey naturale 80x80 31¹/₂"x31¹/₂"







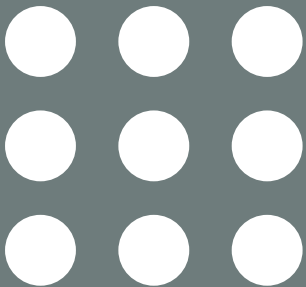









wall: berlin_red naturale 60x120 23^{5/8}"x47^{1/4}"
floor: berlin_red naturale 60x120 23^{5/8}"x47^{1/4}"















MIAMI_WHITE



GRES FINE PORCELLANATO

FINE PORCELAIN STONEWARE / GRÈS CÉRAMÉ FIN / FEINSTEINZEUG-KOLLEKTIONEN / GRES PORCELÁNICO FINO
 SQUADRATO - SQUARED - EQUARRI - REKTIFIZIERT - ESCUADRADO

9 mm 3/8" 	COLOR	SURFACE	60x120	80x80	40x80	60x60	30x60
			23 ^{5/8"} x47 ^{1/4"}	31 ^{1/2"} x31 ^{1/2"}	15 ^{3/4"} x31 ^{1/2"}	23 ^{5/8"} x23 ^{5/8"}	11 ^{4/5"} x23 ^{5/8"}
AIRTECH 	MIAMI_WHITE	NATURALE	760279	760273	760261	760249	760243
		HIGH-GLOSSY	760285	-	-	-	-
		STRUTTURATO	-	-	760267	760255	762197

NEW YORK_LIGHT GREY



GRES FINE PORCELLANATOFINE PORCELAIN STONWARE / GRÈS CÉRAME FIN / FEINSTEINZEUG-KOLLEKTIONEN / GRES PORCELÁNICO FINO
SQUADRATO - SQUARED - EQUARRI - REKTIFIZIERT - ESCUADRADO

9 mm 3/8" 	COLOR	SURFACE	60x120 23 ^{5/8} "x47 ^{1/4} "	80x80 31 ^{1/2} "x31 ^{1/2} "	40x80 15 ^{3/4} "x31 ^{1/2} "	60x60 23 ^{5/8} "x23 ^{5/8} "	30x60 11 ^{4/5} "x23 ^{5/8} "
	NEW YORK_LIGHT GREY	NATURALE	760276	760270	760258	760246	760240
		HIGH-GLOSSY	760282	-	-	-	-
		STRUTTURATO	-	-	760264	760252	762194



STOCKHOLM_GREIGE

GRES FINE PORCELLANATO
 FINE PORCELAIN STONEWARE / GRÈS CÉRAMÉ FIN / FEINSTEINZEUG-KOLLEKTIONEN / GRES PORCELÁNICO FINO
 SQUADRATO - SQUARED - EQUARRI - REKTIFIZIERT - ESCUADRADO

9 mm 3/8" 	COLOR	SURFACE	60x120	80x80	40x80	60x60	30x60
			23 ^{5/8"} x47 ^{1/4"}	31 ^{1/2"} x31 ^{1/2"}	15 ^{3/4"} x31 ^{1/2"}	23 ^{5/8"} x23 ^{5/8"}	11 ^{4/5"} x23 ^{5/8"}
AIRTECH 	STOCKHOLM_GREIGE	NATURALE	760281	760275	760263	760251	760245
		HIGH-GLOSSY	760287	-	-	-	-
		STRUTTURATO	-	-	760269	760257	762199



LONDON_BLACK

GRES FINE PORCELLANATO

FINE PORCELAIN STONEWARE / GRÈS CÉRAMÉ FIN / FEINSTEINZEUG-KOLLEKTIONEN / GRES PORCELÁNICO FINO
 SQUADRATO - SQUARED - EQUARRI - REKTIFIZIERT - ESCUADRADO

9 mm $\frac{3}{8}$ "	COLOR	SURFACE	60x120 $23\frac{5}{8}$ "x47 $\frac{1}{4}$ "	80x80 $31\frac{1}{2}$ "x31 $\frac{1}{2}$ "	40x80 $15\frac{3}{4}$ "x31 $\frac{1}{2}$ "	60x60 $23\frac{5}{8}$ "x23 $\frac{5}{8}$ "	30x60 $11\frac{4}{5}$ "x23 $\frac{5}{8}$ "
	LONDON_BLACK	NATURALE	760278	760272	760260	760248	760242
		HIGH-GLOSSY	760284	-	-	-	-
		STRUTTURATO	-	-	760266	760254	762196



BASEL_GREY

GRES FINE PORCELLANATO

FINE PORCELAIN STONEWARE / GRÈS CÉRAMÉ FIN / FEINSTEINZEUG-KOLLEKTIONEN / GRES PORCELÁNICO FINO

SQUADRATO - SQUARED - EQUARRI - REKTIFIZIERT - ESCUADRADO



9 mm $\frac{3}{8}$ "		COLOR	SURFACE	60x120 23 $\frac{5}{8}$ "x47 $\frac{1}{4}$ "	80x80 31 $\frac{1}{2}$ "x31 $\frac{1}{2}$ "	40x80 15 $\frac{3}{4}$ "x31 $\frac{1}{2}$ "	60x60 23 $\frac{5}{8}$ "x23 $\frac{5}{8}$ "	30x60 11 $\frac{4}{5}$ "x23 $\frac{5}{8}$ "
			NATURALE	760280	760274	760262	760250	760244
AIRTECH		BASEL_GREY	HIGH-GLOSSY	760286	-	-	-	-
			STRUTTURATO	-	-	760268	760256	762198



BERLIN_RED









GRES FINE PORCELLANATO

FINE PORCELAIN STONEWARE / GRÈS CÉRAME FIN / FEINSTEINZEUG-KOLLEKTIONEN / GRES PORCELÁNICO FINO
 SQUADRATO - SQUARED - EQUARRI - REKTIFIZIERT - ESCUADRADO

9 mm 3/8" 	COLOR	SURFACE	60x120	80x80	40x80	60x60	30x60
			23 ^{5/8"} x47 ^{1/4"}	31 ^{1/2"} x31 ^{1/2"}	15 ^{3/4"} x31 ^{1/2"}	23 ^{5/8"} x23 ^{5/8"}	11 ^{4/5"} x23 ^{5/8"}
	BERLIN_RED	NATURALE	760277	760271	760259	760247	760241
		HIGH-GLOSSY	760283	-	-	-	-
		STRUTTURATO	-	-	760265	760253	762195







GRES FINE PORCELLANATO

FINE PORCELAIN STONEWARE / GRÈS CÉRAME FIN / FEINSTEINZEUG-KOLLEKTIONEN / GRES PORCELÁNICO FINO
 SQUADRATO - SQUARED - EQUARRI - REKTIFIZIERT - ESCUADRADO

9 mm 3/8" 	COLOR	SURFACE	30x30 11 ^{4/5} "x11 ^{4/5} "  mosaico tessere 3x3	21x40 8 ^{1/4} "x15 ^{3/4} "  listello sfalsato
AIRTECH	 MIAMI_WHITE	NATURALE	761048	761036
		HIGH-GLOSSY	761042	761030
	 NEW YORK_LIGHT GREY	NATURALE	761049	761037
		HIGH-GLOSSY	761043	761031
	 STOCKHOLM_GREIGE	NATURALE	761050	761038
		HIGH-GLOSSY	761044	761032
	 LONDON_BLACK	NATURALE	761047	761035
		HIGH-GLOSSY	761041	761029
	 BASEL_GREY	NATURALE	761045	761033
		HIGH-GLOSSY	761039	760907
	 BERLIN_RED	NATURALE	761046	761034
		HIGH-GLOSSY	761040	761028

GRES FINE PORCELLANATO

FINE PORCELAIN STONEWARE / GRÈS CÉRAME FIN / FEINSTEINZEUG-KOLLEKTIONEN / GRES PORCELÁNICO FINO
 SQUADRATO - SQUARED - EQUARRI - REKTIFIZIERT - ESCUADRADO

9 mm 3/8" ↑↓				4,6x60 1 4/5" x 2 3/8"	33x120x3 13" x 47 1/4" x 1 1/16"	33x120x3 13" x 47 1/4" x 1 1/16"	33x120x3 13" x 47 1/4" x 1 1/16"
	COLOR	SURFACE		battiscopa	angolo gradino DX	gradino	angolo gradino SX
AIRTECH		MIAMI_WHITE	NATURALE	761078	761054	761066	761060
			HIGH-GLOSSY	761072	-	-	-
		NEW YORK_LIGHT GREY	NATURALE	761079	761055	761067	761061
			HIGH-GLOSSY	761073	-	-	-
		STOCKHOLM_GREIGE	NATURALE	761080	761056	761068	761062
			HIGH-GLOSSY	761074	-	-	-
		LONDON_BLACK	NATURALE	761077	761053	761065	761059
			HIGH-GLOSSY	761071	-	-	-
		BASEL_GREY	NATURALE	761075	761051	761063	761057
			HIGH-GLOSSY	761069	-	-	-
		BERLIN_RED	NATURALE	761076	761052	761064	761058
			HIGH-GLOSSY	761070	-	-	-

AIRTECH

AIRTECH OUTDOOR

Vantaggi tecnici - Technical advantages - Avantages techniques Technische Vorteile - Ventajas técnicas

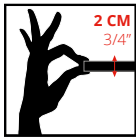

- Lastra monolitica compatta di spessore 2 cm squadrata e rettificata
- Compact monolithic slab 2 cm thick squared and rectified
- Dalle monolithique compacte de 2 cm d'épaisseur, équarrie et rectifiée
- Kompakte monolithische Platte, 2 cm dick, rechteckig und scharfkantig geschliffen
- Losa monolítica compacta de 2 cm de espesor, escuadrada y rectificada.

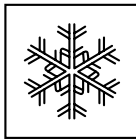

- INGELIVO
- FROST RESISTANT
- INGÉLIF
- FROSTBESTÄNDIG
- RESISTENTE A LA HELADA

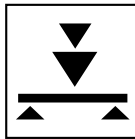

- ELEVATA RESISTENZA AI CARICHI STATICI
- HIGH STATIC LOAD RESISTANCE
- RÉSISTANCE ÉLEVÉE AUX CHARGES STATIQUES
- HOHE STATISCHE BELASTBARKEIT
- ELEVADA RESISTENCIA A LAS CARGAS ESTÁTICAS

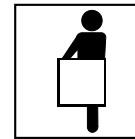

- FACILE DA POSARE
- EASY TO INSTALL
- FACILE À POSER
- VERLEGELEICHT
- FÁCIL DE COLOCAR



- ANTISCIVOLO R11
- ANTI SLIP R11
- ANTIDÉRAPANT R11
- RUTSCHFEST R11
- ANTIDESLIZANTE R11

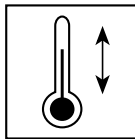

- RESISTENTE AGLI SBALZI TERMICI
- THERMAL SHOCK RESISTANT
- RÉSISTANT AUX ÉCARTS THERMIQUES
- TEMPERATURWECHSELBESTÄNDIG
- RESISTENTE A LAS OSCILACIONES TÉRMICAS



- FACILE DA PULIRE
- EASY TO CLEAN
- FACILE À NETTOYER
- REINIGUNGSLEICHT
- FÁCIL DE LIMPIAR

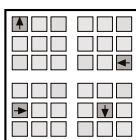

- RIMOVIBILE E RIUTILIZZABILE
- REMOVABLE AND REUSABLE
- DÉMONTABLE ET RÉUTILISABLE
- ENTFERNBAR UND WIEDERVERWENDBAR
- DESMONTABLE Y REUTILIZABLE



- INATTACCABILE DA AGENTI CHIMICI E MUFFE
- IMPERVIOUS TO ATTACK BY CHEMICALS OR MOULD
- RÉSISTANT AUX AGENTS CHIMIQUES ET AUX MOISSISURES
- UNANGREIFBAR DURCH CHEMISCHE STOFFE UND SCHIMMEL
- RESISTENTE A LOS AGENTES QUÍMICOS Y A LOS MOHOS

Applicazioni - Applications - Applications - Verlegung - Aplicaciones

- Posa diretta su erba
- Direct installation on grass
- Pose direct sur de l'herbe
- Verlegung direkt auf Rasen
- Colocación directa sobre hierba

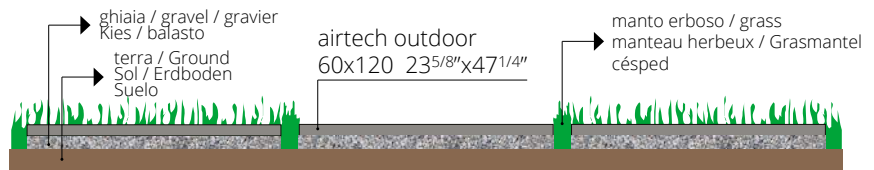

- Posa diretta su ghiaia
- Direct installation over gravel
- Pose direct sur du gravier
- Verlegung direkt auf Kies
- Colocación directa sobre grava



- Posa su massetto cementizio
- Installation on sand-cement screed
- Pose sur chape ciment
- Verlegung auf Zement-Unterbetonblock
- Colocación sobre contrapiso de hormigón

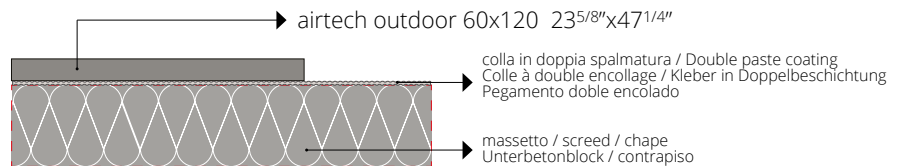

- Posa su piedini fissi o regolabili
- Installation on fixed or adjustable feet
- Pose sur pieds fixes ou réglables
- Verlegung auf feststehende oder regulierbare Füße
- Colocación sobre pies fijos o regulables

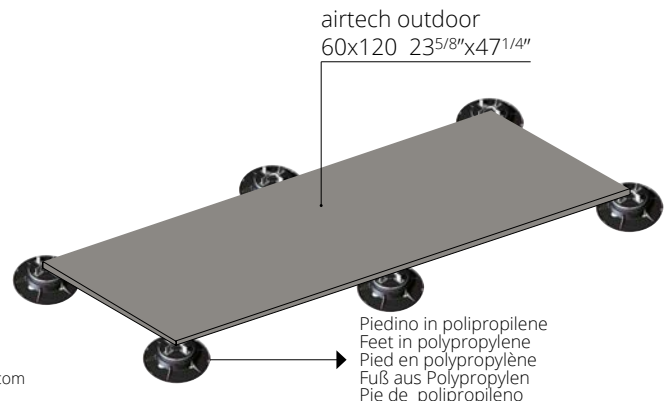

Per le specifiche di utilizzo dei sistemi sopraelevati vedi il sito florim.com
For the specifics on use of raised systems visit the site florim.com
Pour les caractéristiques d'utilisation des systèmes surélevés, voir le site florim.com
Für die Nutzungsbedingungen der Doppelbodensysteme siehe Webseite florim.com
Para las especificaciones de empleo de los sistemas sobreelevados consulte el sitio web florim.com

Le lastre ceramiche sono sottoposte a un trattamento di compattazione termica che assicura resistenza e durata nel tempo. Il bassissimo assorbimento d'acqua rende perciò il materiale ingelivo. Ciò può comportare ristagni d'acqua superficiali anche per materiale installato a regola d'arte. / Ceramic tiles undergo a compacting thermal treatment that ensures resistance and durability. The low level of water absorption makes the slabs frost resistant. This could result in superficial water stagnations even if materials are installed in a workmanlike manner. / Les carreaux de céramique subissent un traitement thermique de compactage qui assure résistance et durabilité. Le bas niveau d'absorption d'eau rend les dalles résistant au gel. Il pourrait en résulter des stagnations d'eau superficielles, même si les dalles ont été installées dans les règles de l'art. / Die Keramikplatten werden einer thermischen Verdichtung unterzogen, welche die Widerstandsfähigkeit und Langlebigkeit sichert. Die extrem niedrige Wasseraufnahme macht das Material frostsicher. Die hohe Materialdichte kann, auch bei einer perfekten Verlegung, eine längere Abtrocknungszeit von angestaumtem Wasser zur Folge haben. / Las baldosas cerámicas se someten a un tratamiento de compactación térmica que asegura resistencia y durabilidad. La baja absorción de agua hace que las baldosas resistan al hielo. Esto podría resultar en estancamientos superficiales de agua, incluso si los materiales están instalados según las reglas del arte.

MIAMI_WHITE



STOCKHOLM_GREIGE





BASEL_GREY



AIRTECH

GRES FINE PORCELLANATO
 FINE PORCELAIN STONEWARE/GRES CERAME FIN/FEINSTEINZEUG-KOLLEKTIONEN/GRES PORCELANICO FINO
 SQUADRATO - SQUARED - EQUARRI - REKTIFIZIERT - ESCUADRADO

20 mm 3/4" ↓		COLOR	SURFACE	60x120 23 ^{5/8} "x47 ^{1/4} "	60x60 23 ^{5/8} "x23 ^{5/8} "
AIRTECH		MIAMI_WHITE	STRUTTURATO	761418	761414
		STOCKHOLM_GREIGE	STRUTTURATO	761420	761416
		BASEL_GREY	STRUTTURATO	761419	761415



SGBP 2018-1992

CE
FLORIM Ceramiche S.p.A SB Via Canaletto, 24 - 41042 Fiorano Modenese (MO) - Italia 05 FLORIM 001
EN 14411:2012 Dry-pressed ceramic tiles, with water absorption $E_p \leq 0,5\%$, for internal and external walls and floorings

Per informazioni relative ai dati tecnici su marcatura CE vedere il sito www.florim.com
 Please refer to our web site www.florim.com for technical information related to CE labelling
 Pour tout renseignements sur l'étiquetage CE veuillez consulter le site www.florim.com
 Informationen bezüglich technischer Daten zur Beschriftung CE entnehmen sie unserer Website www.florim.com
 Para informaciones relativas a las especificaciones técnicas sobre la marca CE, cheques el sitio www.florim.com



	Sistema di gestione della Qualità: Certificato n°. 50 100 1271
	Sistema di gestione dell'Ambiente: Certificato n°. 50 100 100 74
	Sistema di gestione della Salute e Sicurezza dei lavoratori: Certificato n°. 50 100 13825
	Sistema di gestione dell'Energia: Certificato n°. 50 100 13545



GRADO DI VARIAZIONE CROMATICA - DEGREE OF COLOUR CHANGE - DEGRE DE VARIATION CHROMATIQUE - GRAD DER FARBABWEICHUNG - GRADO DE VARIACIÓN CROMÁTICA

<p>V1 LOW THE LEAST AMOUNT OF SHADE AND TEXTURE VARIATION ATTAINABLE IN NATURALLY FIRED CLAY PRODUCTS.</p> <p>Prodotto Monocromatico Produit Monochromatique Einfarbiges Produkt Producto Monocromático</p>	<p>V2 MODERATE LIGHT TO MODERATE SHADE AND TEXTURE VARIATION WITHIN EACH CARTON.</p> <p>Prodotto con leggera variazione cromatica Produit à légère variation chromatique Produkt mit leichter Farbnuance Producto con una pequeña variación cromática</p>	<p>V3 HIGH HIGH SHADE AND TEXTURE VARIATION WITHIN EACH CARTON.</p> <p>Prodotto con marcata variazione cromatica Produit à variation chromatique accentuée Produkt mit ausgeprägter Farbnuance Producto con evidente variación cromática</p>	<p>V4 RANDOM VERY HIGH SHADE AND TEXTURE VARIATION WITHIN EACH CARTON.</p> <p>Prodotto con forte variazione cromatica Produit à forte variation chromatique Produkt mit starker Farbnuance Producto con fuerte variación cromática</p>
		spessore 9mm	spessore 20mm

Quanto contenuto nel catalogo è indicativo e non esaustivo riguardo alle grafiche, decori e ai colori riportati./Contents of this catalog is indicative and not exhaustive with regard to graphics, decors and colors shown. /Le contenu du catalogue est indicatif et non exhaustive en ce qui concerne graphiques, décors et couleurs indiquées. /Die Beschreibungen im Katalog sind indikativ und nicht allumfassend in Bezug auf Grafiken, Dekore und Farben. /El contenido de este catálogo es indicativo y no exhaustivo con respecto a gráficas, decoros y colores ilustrados.



Florim Ceramiche S.p.A. SB

Via Canaletto, 24 /41042 Fiorano Modenese (MO) / T. +39 0536 840111 / F. +39 0536 844750 / florim.com